

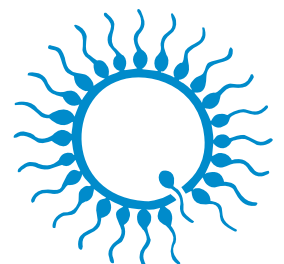

EQUINE

assisted reproduction technology



minitube
our knowledge, your success

Minitube: proven quality since 1970



Dear valued customers,

Minitube is totally committed to quality – this is at the core of everything that we do.

For our worldwide client base, we recognize that reliability, functionality and efficiency are key factors for running a stress-free and profitable production system. For over 50 years Minitube has delivered robust, high-performance, quality equipment and consumables to the assisted reproduction market.

As an industry leader, we accept the responsibility of providing products that do not compromise quality or safety. For this reason, all proprietary consumables and semen or embryo preservation media are manufactured in our own dedicated state-of-the-art facilities, supported by extensive in-house and external third-party QA testing you can trust. Minitube quality is not subjective but based on hard facts and decades of a successful track record.

Our total quality approach is underpinned by a long-term partnership strategy with our suppliers and customers. These long-standing relationships help build the trust and understanding required to ensure ongoing quality.

The same is true for our service team who are always striving to provide the best service within the industry. As a customer, the expert knowledge and know-how of Minitube staff is always available to you.

Moving forward we promise to continue researching and developing the best products and providing the best service, just as we have for more than 50 years.

Dr. Christian Simmet
CEO





Minitube online media library:
All catalogs digitally available in
different languages

CONTENT

1	Semen collection	02
2	Semen evaluation	06
3	Semen dilution	10
4	Liquid semen transport and storage	14
5	Semen straw processing	16
6	Semen freezing and cryostorage	20
7	Insemination and diagnostics	24
8	Embryo transfer and OPU	28
9	Training and service	36

1 SEMEN COLLECTION



Hannover artificial vagina

With valve, inner liner (100 cm), 3 rubber rings, and leather handle. Robust tubular rubber casing with rounded openings. Valve assembly allows air to be added for adjustment of inner pressure.

Hannover artificial vagina [1] 11220/0145

Accessories

Inner liner for Hannover AV, latex, roll-up ends, sterilizable [2]

long version, 100 cm 11222/0002

short version, 70 cm 11222/0003

Disposable inner liner for Hannover AV,

25/package 11245/0450

width 21 cm, roll with approx. 200 m; „sensitive“:
smooth and resistant material [3] 11222/0120

Rubber band for Hannover AV [4] 11222/0001

Leather handle for Hannover AV [5] 5011222/0008



Missouri artificial vagina

Double latex liner with valve and leather casing, adapter, and collection bottle. Valve assembly allows air to be added for adjustment of inner pressure.

Missouri artificial vagina [1] 11245/0000

Accessories

Double latex liner for Missouri AV, 70 cm 11245/00011

Disposable inner liner for Missouri AV, 25/package 11245/0450

Colorado artificial vagina

With 3 inner liners (tubular, conical, straight), 10 rubber bands, 2 clamps, 25 disposable inner liners, 25 semen bottles, 25 coupling nuts, 25 nylon filters, and warming bag. Robust tubular plastic casing with rounded openings. Valve assembly allows air to be added for adjustment of inner pressure.

Colorado artificial vagina [2] 11230/0000

Accessories

Inner liner for Colorado AV, latex, tapered end for connection to the bottle

straight form [3] 11231/0101

tubular, flared ends 11231/0103

Disposable inner liner for Colorado AV, 25/package [4] 11232/0110

AV shaped, 25/package [5] 11232/0102

width 31 cm, roll with approx. 200 m; „sensitive“: smooth and resistant material [6] 11232/0030

Warming bag for Colorado AV [7] 11231/0185

Accessories for all artificial vaginas

Semen collection bottle
200 ml, plastic, disposable, 100/package [8] 11231/0200

250 ml, glass 11245/0006

Warming bag for collection bottle, protects the semen from low temperature and UV radiation [9] 11225/0026

Coupling nut, for semen collection bottle, 100/package 11231/0301

Semen filter, nylon, fits semen collection bottle, 25/package [10] 11231/0400



Semen filter pouch,
non-woven, 150 x 60 mm, 100/bag [11] 11245/3100
non-woven, 125 x 90 mm, 10/bag 11260/1000

Thermometer for artificial vagina,
up to +100°C, bimetal, non-breakable [12] 11027/0000
up to +200°C, graduation 0.1°C, red filling [13] 11027/0200

HUMANS AND ANIMALS IN FOCUS

Designed to combine highest security with the best possible comfort for the stallion and the collection technician.

Stallion phantom Hannover

Product features

- Covered with reinforced synthetic coating for a very high level of hygiene: can easily be washed and effectively be disinfected
- Well-padded to ensure highest comfort even to heavily stimulated stallions
- Contoured body style makes it possible to hold and offer the AV at a most natural position
- Easy to install and very stable: two tubular legs fixed on the floor with four screws each ensure highest security for operators and stallions
- Size of the phantom fits for all breeds: body size 2 m x 60 cm x 55 cm (L x W x H) and shoulder height 1.30 m to 1.70 m

Stallion phantom Hannover, with removeable bite belt [1]

height and tilt angle adjustable to meet needs of different breeds and preferences **11200/0000**

with hydraulic height adjustment: both feet can be lifted or lowered about 40 cm either individually or together by means of a hand pump **11200/1000**

Accessories

Cover for phantom, synthetic material, collection side closed, with belts for attachment [2] **11200/2601**

Bite belt [3] **11200/2100**

Stretch foil for protection of phantom, 300 m **32000/0010**



1



2



3

Warming cabinet

For drying, warming and sterilization of lab materials.

Product features

- Temperature range: +30°C to +300°C
- Natural ventilation
- Display with multi touchscreen
- Multifunctional PID microprocessor controller
- 1 Pt-100 sensor with double abnormal temperature protection (adjustable electronic temperature monitoring and mechanical temperature limiter)
- Adjustable addition of preheated fresh air

Warming cabinet

53 l, 400 x 400 x 330 mm, 55 kg, 230 V **14127/0053**

53 l, 400 x 400 x 330 mm, 55 kg, 115 V **14127/0054**



Many other warming cabinet sizes available!

Sterivar

Low pressure sterilizer, specially designed for artificial vaginas and accessories.

Product features

- Made of stainless steel, double wall with insulation
- With pressure safety valve, timer, water drain and protection against overheating
- Capacity: 15 artificial vaginas
- Temperature range: up to +100°C
- Pressure: max. 0.02 bar
- Inside dimensions: 750 x 400 mm
- Power supply: 115 V/60 Hz or 230 V/50 Hz
- Power consumption: 3500 W

Sterivar [1]	
230 V	11050/0015
115 V	11050/0014
Roller base for Sterivar [2]	
	11051/0000



Accessories for semen collection

Semen collection glove, blue, nitrile, extra sensitive, sperm safe, latex-free, powder-free, 100/box [1]	
size M	11128/0055
size L	11128/0060
size XL	11128/0065
Infrared thermometer, for temperature measurement without contact, with case and battery [2]	
15120/7000	
ReproJelly, non-spermicidal lubricant, water soluble	
tube with 100 ml, resealable [3]	11907/0100
3 l canister, without dispenser [4]	11907/3000
Dispenser for ReproJelly canister	
	11907/3100
Vaseline, 1 kg	
	11905/0100
Lubricating jelly Bengen, 1 l, water soluble	
	11906/1000



REPROJELLY LUBRICANT

Iso-osmotic and sperm friendly, supports the sperm cell viability. Ideal viscosity to better coat gloves, AI equipment and instruments.

2 SEMEN EVALUATION



AndroScope

AndroScope is a **compact mobile CASA system** that is based on AndroVision® and allows the operator to analyze semen motility and concentration of various species at any point in the production, transport, and insemination process.

AndroScope is equipped with a professional high-speed camera and a robust focus adjustment for precise semen analysis. The heating unit in the analysis area of the mobile CASA reaches +37°C within a few seconds, so that semen analysis is performed at optimal temperature conditions. AndroScope works with every PC, laptop, or tablet where MS Windows 10 or newer is installed (USB-3.0 plug is necessary to connect the device).

A practical, robust carry case provides optimal protection for the transport and contains everything you need to perform a semen analysis.

AndroScope [1] incl. transport case and accessories 12500/3000

Accessories

Disposable counting chamber Minitube, 20 µm, 4 chambers, 25/box 12050/0220

Test tube 2 ml with cap, 250/bag 14602/0904

Disposable capillary tube, 100/bag 15404/0100

Micro fiber rod, length 124 mm, 100/bag 12510/0106

Option: Mobile warming unit, for 6 reaction vials and 1 slide [2] 12057/6000



more information

AndroVision®

This highly precise, automated system for computerized semen analysis stands out for the integration of the classic CASA analysis with more advanced assays for sperm functionality. Concentration and motility as well as acrosome integrity, viability, mitochondrial activity, and DNA integrity can be assessed accurately and quickly with up to 1000 cells per field, making AndroVision® the perfect tool for the **objective and complete semen evaluation**.

The user interface is straightforward and easy to understand: **only three clicks from start to analysis result**. An optional touch screen interface and barcode scanner enhances the system for even quicker and more efficient application.

AndroVision® software	
with PC and monitor [1]	12500/0000
with PC, touch screen and barcode scanner	12500/0001
with laptop	12500/0010
AndroVision® high speed color camera [2]	12500/4400

Product features

- Real time analysis of live images and video files
- Analysis of up to 4 fields in 20 seconds
- Highly efficient particle filter for accurate sperm identification
- Analysis profiles for many species
- Adjustable analysis parameters and user created profiles
- Data export to MS Excel and other programs
- Languages: English, German, Spanish, Chinese, Portuguese, Russian, French

Accessories

Phase contrast microscope Zeiss Axiolab 5* [3]	12008/0020
ScanStage, automated microscope stage with integrated heating system [4]	12048/0031
Controller HTi 200 [5]	12057/0200
Warming plate, 245 x 200 mm [6]	12057/0510

* Other microscopes from our product portfolio can also be used with AndroVision®. Please contact us for an individual offer.



AndroVision® software modules

Module Morphology and Morphometry	12500/1300
Module Viability*	12500/1400
Module Acrosome Integrity*	12500/1600
Module Mitochondrial Activity*	12500/1700
Module DNA Integrity*	12500/1800

* Requires fluorescence microscope.



more information

Phase contrast microscope CX 43

Product features

- Phase achromat optics with universal condenser
- Heated microscope stage with temperature control unit HTi 200 and additional warming plate (180 x 180 mm)
- Integrated LED illumination
- Ergonomic design

Phase contrast microscope CX 43, with phototube (trinocular), objectives 20x, 40x **12005/0042**



Wide range of microscopes and accessories available!

Phase contrast microscope MBL

Functional microscope for semen analysis with heating system and control unit for freely adjustable temperature.

Phase contrast microscope MBL 2000

binocular, heated stage, HTi 50, objectives 10x, 40x, 100x **12010/3000**

binocular, heated stage, HTi 50, objectives 10x, 40x, 100x, with camera and monitor [1] **12010/3050**

Phase contrast microscope MBL 2100

trinocular, heated stage, HTi 50, objective 20x **12010/3103**

trinocular, heated stage, HTi 200, objective 20x, with camera and monitor **12010/3101**

Digital color camera for microscopes, with integrated image display software [2] **12110/1600**

Monitor 11.6" with HDMI input [3] **12110/1610**

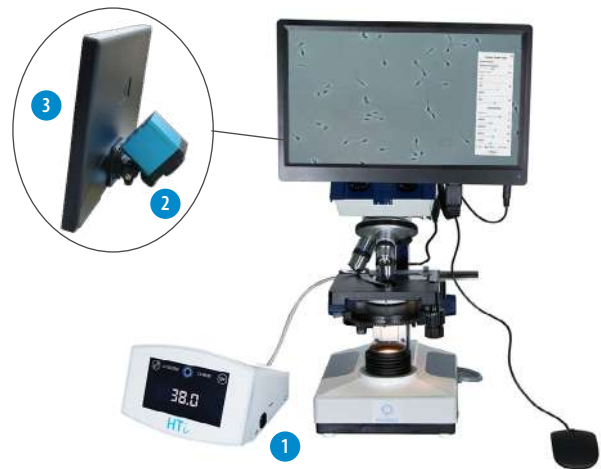

Semen stains

Spermac, stain for morphology analysis, 4 x 50 ml [1] **15405/0000**

Farelly stain, for morphology analysis, 3 x 250 ml [2] **15405/0026**

Eosin G, 2% solution for supravital staining, 50 ml [3] **15405/0025**

Nigrosin, 4% solution for supravital staining, 50 ml [4] **15405/0029**



Laboratory scale

Precision scale for the determination of the ejaculate volume, weighing range max. 2000 g, resolution 0.1 g, weighing pan 130 x 130 mm.

Laboratory scale **14295/0444**



Glass ware

We offer a variety of measuring pipettes, graduated cylinders, beakers, dispensers, test tubes, Erlenmeyer flasks etc. Please contact us for further information!



Microscopy supplies

Microscope slide, 76 x 26 mm, 50/box [1]	15400/2400
Cover glass, 18 x 18 mm, 100/box [2]	15401/0990
Immersion oil, 8 ml [2]	12000/0101
Lens cleaning tissue, 90 x 72 mm, 500/package [4]	15230/9100



Counting chambers (hemocytometers)

Thoma new	15150/4771
Neubauer improved	15152/4421
Bürker	15153/0000



Pipettor

Adjustable single channel pipette, yellow, autoclavable, 10 - 100 µl	12425/4810
Pipette tip, 10 - 100 µl, yellow, 1000/bag	12425/9409



Photometer SDM 1

Product features

- Raw semen samples can be used without dilution
- Semen concentration is displayed in 10^6 sperm/ml
- Electrical connection: with included mains adapter 100-240 V or batteries

Photometer SDM 1, calibrated for equine semen [1]	12300/0101
---	------------

Accessories

Microcuvette for SDM 1, 100/box [2]	12300/1111
Multispecies software, for reprogramming to other species	12300/0130



PROVEN ACCURACY

SDM 1 is a compact, highly precise photometer for measuring sperm concentration. Cleaning is simple, maintenance is minimal.

3 SEMEN DILUTION



■ Beyond®

The extender for long-term storage of chilled stallion semen.

⚙️ Product features

- Semen storage and transport for up to 14 days at +5°C
- The semen of so-called “poor coolers” – stallions that do not respond well to chilling and freezing or have low initial semen quality – can be stored for up to 7 days at +17°C
- Less collections and more flexible logistics of AI
- Longer storage time decreases the number of shipments of insemination doses
- Chemically defined, purely synthetic extender
- Ready-to-use in 100 ml bottles
- Lower risk of causing uterine inflammation
- Produced and quality controlled under GMP-certified guidelines
- Three easy steps for preparation: 1 to 1 dilution with pre-extender – centrifugation with or without CushionFluid – final dilution to 50-100 million sperm cells/ml with Beyond®

Beyond®, 100 ml ready-to-use extender

13570/0100



GAME-CHANGER FOR THE HORSE BREEDING INDUSTRY

With Beyond®, storage of stallion semen is finally possible for up to 14 days at +5°C.



more
information

EquiPlus

Balanced medium based on skim milk for preservation of sperm activity up to 72 hours. Designed for +5°C storage and transport.

EquiPlus powder* [1]	
for 1 l, with Lincomycin and Spectinomycin	13570/0202
for 100 ml, with Lincomycin and Spectinomycin	13570/0210
for 100 ml, with Amikacin and Penicillin	13570/0215
for 1 l, without antibiotics	13570/0201
for 100 ml, without antibiotics	13570/0240
EquiPlus Combi, powder with 100 ml double distilled water [2]	
with Lincomycin and Spectinomycin	13570/0220
with Gentamicin	13570/0221
without antibiotics	13570/0222
EquiPlus liquid [3]	
100 ml, with Lincomycin and Spectinomycin	13570/0251
100 ml, with Amikacin and Penicillin	13570/0263
100 ml, with Ticarcillin	13570/0262
100 ml, with Gentamicin	13570/0301

* Distilled water not included.

Gent

Culture medium in which fresh semen can be preserved at +4°C to +6°C for approx. 72 hours. With egg yolk and antibiotic. Supplied frozen, ready-to-use after warming.

Gent, 45 ml	13571/0045
-------------	------------

Extender preparation

CushionFluid, for gentle centrifugation of stallion spermatozoa, assures a higher yield of sperm cells as compared to standard centrifugation	
100 ml [1]	13580/0001
30 ml	13580/0030
Centrifugation medium, powder for 1 l transparent EDTA-Glucose solution [2]	13565/0001
Double distilled water, sterilized, pyrogen-free	
1 l [3]	13570/1000
100 ml	13570/1100

PERFECT COMBINATION

The combination of extender powder (contained in the lid) and sterile, pure water (in the bottle) ensures that EquiPlus Combi is extremely easy to prepare.



Semen dilution



Spectrum - The SBS CryoSystem

The SBS CryoSystem consists of a range of Spectrum freezing extenders, which feature different cryoprotectants and specific different egg yolk or milk content. The Spectrum concept allows to identify the best freezing extender for each individual stallion. It is possible to achieve pregnancy rates with frozen-thawed semen which are comparable to cooled semen.

Five ready-to-use solutions are available, designed for transport and storage at -20°C.



more information



Spectrum Orange	
30 ml	13572/0020
15 ml	13572/0200
Spectrum Red	
30 ml	13572/0030
15 ml	13572/0300
Spectrum Green	
30 ml	13572/0040
15 ml	13572/0400
Spectrum Blue	
30 ml	13572/0050
15 ml	13572/0500
Spectrum Violet	
30 ml	13572/0060
15 ml	13572/0600

Low in milk and egg yolk
Best combined with slow cooling and freezing

High egg yolk content, no milk
Best combined with rapid cooling and freezing

Milk-based, low in egg yolk
Best combined with rapid cooling and freezing
Beneficial for certain stallions only

Low in milk and egg yolk
Best combined with slow cooling and freezing
Cryoprotectant is highly membrane permeable

Low in milk, contains egg yolk
Best combined with slow cooling and freezing
Balanced combination of cryoprotectants



Spectrum Duo

Spectrum Duo is a new presentation of the SBS Spectrum extenders, designed for easier logistics. Providing the same results as the ready-to-use options, the Spectrum Duo extenders consist of two components that can be easily blended into the finished product by adding egg yolk. Transport at <+20°C, storage at <+8°C.

Spectrum Duo Red	13572/0230
Spectrum Duo Violet	13572/0260

Not available in
USA and Canada



Spectrum test freeze kit

The kit contains: 2x Spectrum Orange (15 ml), 2x Spectrum Red (15 ml), 1x Spectrum Blue (15 ml), 1x Spectrum Violet (15 ml), 1x Spectrum Green (15 ml), 2x CushionFluid (30 ml), 2x SBS Centrifugation Medium (120 ml).

Spectrum test freeze kit	13572/0000
--------------------------	------------





Many other
water
bath sizes
available!

Water bath

- Electronic temperature control, stainless steel, with grid and lid
- Working temperature range: minimum 5°C above ambient up to +100°C (depending on ambient pressure)
- Intuitive 3.5" color graphic display with touch screen
- Inner dimensions: 267 x 200 x 207 mm (L x H x D)
- Outer dimensions: 349 x 378 x 289 mm (L x H x D)

Water bath, 10 l

230 V	14079/0001
110 V	14079/0002



Centrifuge Minitube

- With swing out rotor
- Complete with buckets for vials: 4 x 100 ml/4 x 50 ml/8 x 15 ml
- Speed in g (RCF) and rpm: max. speed 4000 rpm/2200 x g
- Memory: 100 programs
- Dimensions: 380 x 300 x 490 mm (W x H x D)

Centrifuge Minitube

230 V	14601/0000
110 V	14601/0001



Rotating mixer RM5

- For gentle, constant homogenization of semen doses in tubes
- Appropriate for use inside the refrigerator
- With 5 rollers; roll length: approx. 320 mm
- Dimensions: 430 x 110 x 180 mm (W x H x D)

Rotating mixer RM5

230 V	14340/0348
110 V	14340/0349



Shaking device VIBRAMAX 100

- Platform with two fixation devices and non-slip rubber pad, includes timer
- Shaking rate: continuous electronic regulation (150 -1350 rpm)
- Shaking amplitude: 3 mm
- Timer: 0-120 min, pre-selectable, continuous operation possible
- Area of platform: 220 x 220 mm

Shaker

230 V	14703/0304
110 V	14703/0305



4 LIQUID SEMEN TRANSPORT AND STORAGE



Plastic vials

Plastic vial, with graduation

50 ml, screw cap, flat base, sterilized, 25/bag [1]	17220/0017
30 ml, screw cap, flat base, sterilized, 50/bag [2]	17231/0030
13 ml, screw cap, round bottom, sterilized, 100/bag [3]	17230/6001
13 ml, without cap, round bottom, 100/bag	17230/6000

Accessories

Screw cap, for 13 ml plastic vial, 1000/bag [4]

white	17230/6054
red	17230/6055
blue	17230/6056
violet	17230/6057
green	17230/6058
yellow	17230/6059

Rack, for 20 plastic vials 12/13 ml, acrylic glass	17230/9384
--	------------



IMPROVE YOUR CO₂ FOOTPRINT

The Jute transport box is a sustainable, space-saving, and functional packaging solution. The inlays are 100% compostable.

Jute transport box

Product features

- Made of Jute, a naturally renewable raw material
- Holds constant temperature for up to 30 hours
- Includes cardboard box, Jute inlays, 2 cool packs and 2 plastic tubes (50 ml)
- Outer dimensions: 200 x 185 x 200 mm (W x D x H)

Jute transport box

17229/0001



Neopor transport box

Product features

- Made of highly insulating Neopor
- Holds constant temperature for up to 45 hours
- Includes transport container, cardboard box, 2 cool packs, 2 disposable syringes (20 ml), 2 protecting caps for syringe, 2 plastic tubes (13 ml)
- Outer dimensions: 290 x 290 x 180 mm (W x D x H)

Neopor transport box

17229/0002



Sterile bags

Sterile bag, with incorporated wire and labeling field, 100/package

60 ml	17224/0250
120 ml	17224/0500
350 ml	17224/1000



Disposable syringes

Disposable syringe, Luer mount, all plastic, sterilized

1 ml, 100/package	19801/0001
2 ml, 100/package	19801/0002
5 ml, 100/package	19801/0005
10 ml, 100/package	19801/0010
20 ml, 100/package	19801/0020



5 SEMEN STRAW PROCESSING



SFS 133

Product features

- Semiautomatic filling and sealing machine
- Straws are filled and sealed 6 by 6
- Sealing is done securely and hygienically with metal sealing balls
- An air bubble of 1 cm is automatically produced in each straw
- Capacity: approx. 2000 straws/hour

SFS 133, for 0.5 ml straws, with vacuum bottle, filling and suction head, straw magazine **13133/0133**

Low density vacuum pump, 30–60 Hg, with manometer and valve
230 V/50 Hz **13133/0267**
115 V/50 Hz **13133/0268**

Cartridge loading device, with loading block and 10 cartridges for 36 straws 0.5 ml **13133/0005**

Accessories

Filling head with 6 nozzles **13133/1000**

Suction head with 6 nozzles **13133/2000**

Washer, for all filling and suction nozzles, 5000/bag **13021/3001**

Silicone tubing for SFS, transparent, 3 x 1 mm, length 10 m **13133/3550**

Metal sealing ball for 0.5 ml straws **13400/9900**



MPP Uno

Seals and fills 1 straw per cycle – ideal for handling small volumes.

Product features

- Automatic filling and sealing machine for 0.25 and 0.5 ml straws
- Capacity: approx. 4000 straws/hour
- Fast, tool-free conversion between 0.25 and 0.5 ml straws and vice versa (1-2 minutes)
- Exchangeable hopper, capacity: 2400 MiniStraws (0.25 ml) or 1200 medium straws (0.5 ml)
- Ultrasonic sealing unit, ultrasonic generator in an external casing that can be installed at up to 2.5 m (ON/OFF switch directly on the machine)
- Designed to provide ideal conditions for hygiene and safety
- Can be operated in cold room or cabinet or at room temperature as stand-alone or combined with MiniJet printer (CombiSystem)
- Very compact device which takes up little space; machine dimensions: 460 x 350 x 410 mm (W x H x D) plus ultrasonic generator
- Vacuum unit with integrated reservoir and automatic readjustment function; vacuum level can be easily modified via buttons
- PLC microprocessor control
- Power supply: 110 V/60 Hz or 230 V/50-60 Hz

MPP Uno, complete [1]

13017/0000

Accessories

Filling nozzle, for 0.5 ml straws [2]

13017/0017

Suction nozzle, for 0.5 ml straws [3]

13017/0027

Straw hopper, for 0.25 and 0.5 ml straws [4]

13018/0006

Washer, for 0.25 ml and 0.5 ml nozzles, 5000/bag

13021/3001

Filling and suction tubing, 380 mm, sperm-friendly material (silicone), angle cut edge, 100/aluminum foil bag

13021/3800

Disposable semen cone, 100/bag [5]

13018/0100

Fixing unit, for filling and suction blocks, stackable, stainless steel [6]

13017/0050



more information

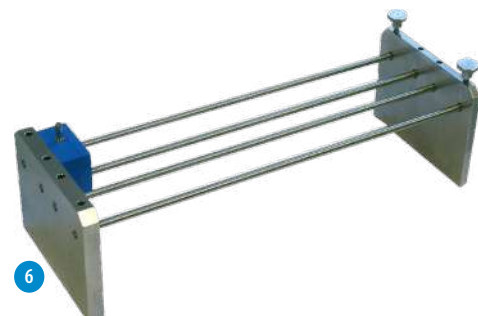

Semen straw processing

EasyCoder

Clean and odorless printing of straws without ink and solvent.

Product features

- Thermal transfer printer with automatic straw supply (output: up to 3600 straws per hour) for immediately abrasion-resistant print
- Unparalleled precise and clear printing on 0.5 and 0.25 ml straws; easy and quick conversion between different straw sizes
- Prints up to 3 lines per straw, including barcodes, logos, and special characters
- Control via PC by a clear and user-friendly Minitube software
- Easy handling, little maintenance required
- Dimensions (L x W x H): 660 x 370 x 310 mm (PC not included)
- Power supply: 110 V/50-60 Hz or 230 V/50-60 Hz

EasyCoder printer 13038/0000

Thermal transfer ribbon, black 13038/0010



more information

MultiCoder

Quick and easy machine-readable labeling of lab items.

Product features

- High resolution inkjet printing
- Print head protection system (avoids drying out of ink)
- Wide variety of product carriers
- No tools needed for change of product carriers
- Pre-designed print layouts
- Loads excel files for printing
- Easy drag & drop editing of print layouts

+ Your benefits

- + Very versatile: print system can label most kinds of materials such as plastics, glass, or aluminum
- + Manually moveable slide and a unique, easy-to-use carrier system allow for a speedy work process
- + Easy printing of information on the smallest amount of space, including text, barcode, QR-Code, and logo

MultiCoder printer 13145/0000



UNIQUE, FLEXIBLE & VERSATILE

Quick and easy print on a whole range of items: semen straws, goblets, cassettes, culture dishes, Macrotubes, syringes, cryovials and many more.



more information













Semen straws

For over 30 years, Minitube straws have been used worldwide as a standard for the freezing of semen. Minitube's quality control process, production techniques, and material selection ensure for a **reliable product** that consistently exceeds industry standards.

EcoStraws feature a wick with a shorter inner wick section that **absorbs 3 to 4% fewer sperm** than the corresponding symmetrical wick of standard semen straws. They are ideal for overnight equilibration of semen at refrigerated temperatures. EcoStraws are used in exactly the same way as standard semen straws.



Semen straws are available pre-printed upon request.

	Medium straw 0.5 ml	EcoStraw 0.5 ml
transparent	 13408/0010	13408/3010
red - transparent	 13408/0044	13408/3044
green - transparent	 13408/0054	13408/3054
blue - transparent	 13408/0064	13408/3064
grey - transparent	 13408/0074	13408/3074
yellow - transparent	 13408/0094	13408/3094
pink	 13408/0100	13408/3100
turquoise	 13408/0130	13408/3130
orange - transparent	 13408/0144	13408/3144
beige - transparent	 ---	13408/3184
pistachio - transparent	 13408/0204	13408/3204
white	 13408/0210	13408/3210

Macrotubes

Macrotube, 100/bag [1]	
2.5 ml, length: 140 mm	13441/0133
4 ml, length: 240 mm	13441/0240
5 ml, length: 280 mm	13441/0280
Sealing ball for Macrotube, 1000/bottle [2]	
metal	13440/0000
glass, blue	13440/0100
glass, green	13440/0200
glass, red	13440/0600
glass, yellow	13440/0900



6 SEMEN FREEZING AND CRYOSTORAGE



Freezing units

Minitube freezing units are compact and easy to handle. They are made of a high-quality Styrofoam box, an inner container of stainless steel and a floating rack. The stainless steel container is filled with liquid nitrogen. The rack keeps the needed distance between 0.5 ml or 0.25 ml straws during the first down phase, while it floats on liquid nitrogen. After that, the straws get manually immersed into the nitrogen.

- Distance between straws and liquid nitrogen level can be adjusted
- Fits 0.5 ml and 0.25 ml straws
- Low nitrogen consumption
- High quality Styrofoam chest and stainless steel inner box
- Easy transport

Freezing unit

for 20 straws [1] [15043/0636](#)

for 90 straws [2] [15043/0736](#)

Accessories

Loading block for 90 straws floating rack [15043/0738](#)

Additional rack

for freezing unit for 20 straws [3] [5015043/0600](#)

for freezing unit for 90 straws [4] [5015043/0900](#)



Automatic freezer IceCube 14S

Computer controlled freezer, with comfortable data input and automatic recording of the freezing curve.

Product features

- Temperature range: +40 to -180°C
- Freezing rates: 0.01 to 60°C/min
- Heating rates: 0.01 to 15°C/min
- Display accuracy: 0.01°C
- Temperature measurement via 2 Pt-100 resistance thermometers
- Capacity: approx. 900 x 0.5 ml straws per freezing cycle
- Software for freeze programming and control: unlimited storage of programs and processed files, color graphic display of all temperature curves, wide possibility of parameter settings
- Dimensions: 540 x 420 x 520 mm (L x W x H), weight: 29 kg

IceCube 14S, with connector kit for LN ₂ pressure container	
with 10" tablet [1]	16821/3000
with 12" touch screen monitor*	16821/2000
without screen*	16821/1000

Accessories

Rack for IceCube 14S, for 36 straws [2]	16821/5036
Loading device for straw rack	16821/5037
Handling rack for IceCube 14S [3]	16821/5030
Spacer for IceCube 14S [4]	16821/5018
LN ₂ pressure container, 60 l	16820/1900
Roller base for LN ₂ pressure container	16501/0204
Pliers for racks [5]	16821/5031

Embryo freezing with the IceCube:

Autoseeding preparation for freezing embryos	16821/5019
Autoseeding rack (spacer included) [6]	
capacity: 35 x 0.5 ml straws	16821/5020
capacity: 43 x 0.25 ml straws	16821/5021

* To connect to own PC or laptop.



Larger alternative:
IceCube 14M



1



2



3

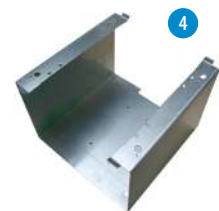

4



6



5

Semen freezing and
cryostorage

Goblets

Goblets [1]		
Ø 7.1 mm	white	16907/0071
Ø 10 mm	white*	16910/0010
Ø 13 mm	white*	16913/0133
Ø 35 mm	white	16935/0135
Ø 53 mm	white	16953/0133
Ø 65 mm	white	16965/0133
hexagonal	white	16970/0136

* Available in different colors.

Accessories

Goblet canes [2]	
for 2 x 7.1 mm goblets	16965/6171
for 2 x 10 mm goblets	16965/6000
for 2 x 13 mm goblets	16965/6013
Marking label for goblet canes, different colors	13422/00xx
Divider for goblets, 100/bag, 12 x 6.5 cm [3]	16967/0065
Identification rod, 140 mm length	
for 0.25 ml straw	16903/0210
for 0.5 ml straw	16903/1210
Stainless steel funnel for 65 mm goblets [4]	15004/0402



Cassettes for straw storage

	Triangular cassette [1]*		Flat cassette [2]**	
	long	short	long	short
green	16981/01351	16981/01201	16980/1201	16980/0601
blue	16981/01361	16981/01211	16980/1202	16980/0602
yellow	16981/01371	16981/01221	16980/1203	16980/0603
red	16981/01381	16981/01231	16980/1204	16980/0604
white	16981/01391	16981/01241	16980/1205	16980/0605
beige	16981/01401	16981/01251	16980/1206	16980/0606
orange	-	-	16980/1207	16980/0607

* For 10/20 straws 0.5 ml or 28/56 straws 0.25 ml.

** For 3/6 straws 0.5 ml or 6/12 straws 0.25 ml.

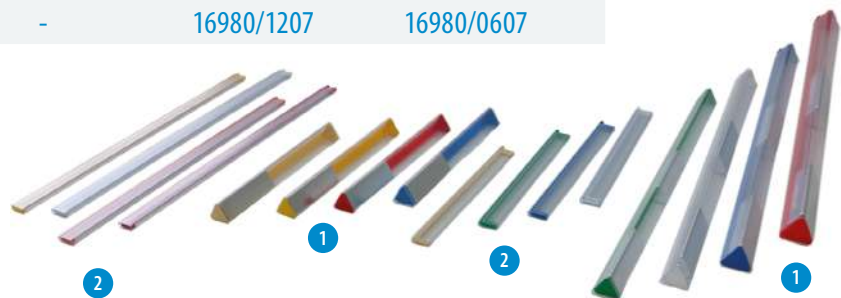



Further cryostorage container options/sizes

Cryostorage container

- With 6 canisters 279 x 38 mm
- Normal working duration: 175 days
- Neck opening: 55 mm
- Overall height: 690 mm
- Capacity: 3732 x 0.5 ml straws
- Full weight: 42 kg

MVE Cryo container ET 35, volume: 36 l

16503/3606



Vapor Shipper

- 1 canister 278 x 67 mm
- Static holding time: 13 days
- Static evaporation rate: 0.26 l/day
- Capacity: 938 x 0.25 ml/440 x 0.5 ml straws (1 level bulk)
- Neck opening: 70 mm
- Height: 468 mm
- Diameter: 222 mm

MVE Vapor Shipper SC 4/2 V, volume: 3.6 l [1]

16504/2001

- 1 canister 278 x 46 mm
- Static holding time: 21 days
- Static evaporation rate: 0.20 l/day
- Capacity: 452 x 0.25 ml or 210 x 0.5 ml straws
- Neck opening: 51 mm
- Height: 492 mm
- Diameter: 222 mm

MVE Vapor Shipper SC 4/3 V, volume: 4.3 l [2]

16504/3001

Protective shipping container, for Vapor Shipper, made of plastic, IATA compliant [3]

16504/3010



Semen freezing and cryostorage

CryoCube™ Dry Shipper

- 1 canister 127 x 35 mm
- Static holding time: 5 days
- Capacity: 182 x 0.25 or 88 x 0.5 ml straws
- Neck opening: 35 mm
- Height: 305 mm
- Diameter: 305 mm

CryoCube™ Dry Shipper

16505/0100



7 INSEMINATION AND DIAGNOSTICS



Universal insemination pipette

Product features

- Suitable for liquid and frozen-thawed semen in straws
- Smooth round tip for gentle introduction
- Flexible shaft facilitates handling; long pipettes with ultra flexible shaft for deep intrauterine insemination
- Precision tooled tip with inner cone for 0.5 ml straws to allow direct position of semen into the uterus and to ensure 100% semen delivery
- If used with the AI stylet for 0.5 ml straws, the same pipette can be reloaded with consecutive straws in situ
- Finger handle with adapter to fit syringe and Macrotube straw

Universal pipette

length: 57 cm, 5/bag	17209/0005
length: 57 cm, 1/bag, sterilized	17209/0001
length: 65 cm, 5/bag	17209/1165
length: 65 cm, 1/bag, sterilized	17209/1265
length: 75 cm, 5/bag	17209/1175
length: 75 cm, 1/bag, sterilized	17209/1275

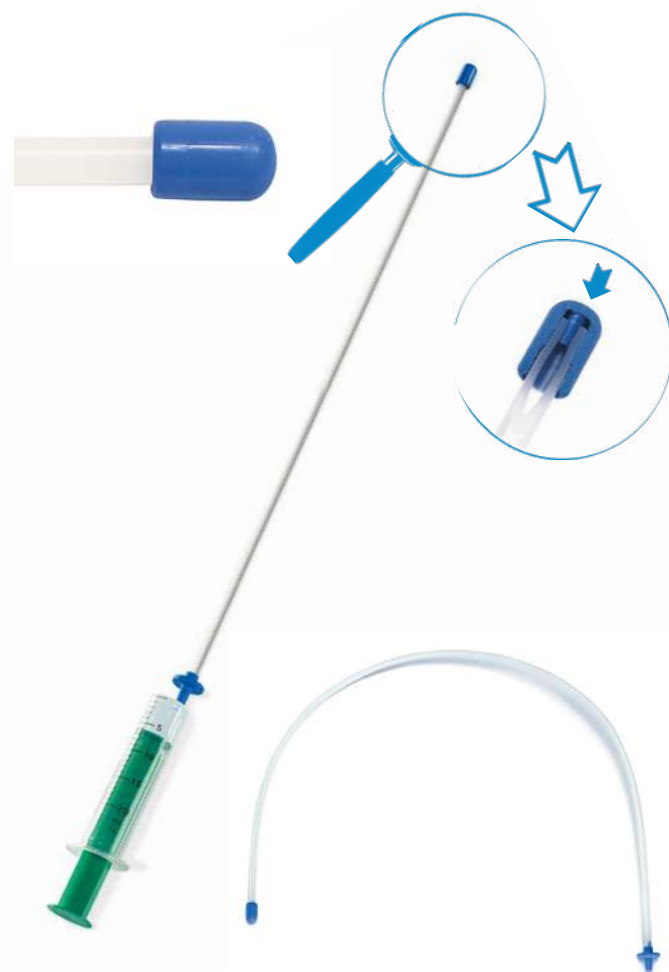

Deep intrauterine insemination pipette

For deep intrauterine insemination (IUI) with small volumes of liquid semen if straws cannot be used. The pipette is equipped with an inner catheter to reduce the volume of the channel where the semen must pass through.

IUI pipette with inner catheter	
length: 65 cm, 5/bag	17207/1165
length: 65 cm, 1/bag, sterilized	17207/1265
length: 75 cm, 5/bag	17207/1175
length: 75 cm, 1/bag, sterilized	17207/1275

Flexible stylet

Flexible stylet for deep intrauterine or transcervical insemination of mares with universal pipette and 0.5 ml straws. Semen in 0.5 ml straws is directly placed into the uterus, ensuring 100% semen delivery. The stylet is made of stainless steel and is provided with 2 knobs to pull out empty straws, thus the same pipette can be reloaded several times.

Flexible stylet	
length: 57 cm	17209/1057
length: 65 cm	17209/1065
length: 75 cm	17209/1075

Insemination pipettes for liquid semen

Insemination pipette	
with Luer end, 60 cm, rounded tip, 25/bag [1]	17209/2000
with Luer end, 65 cm, larger diameter, rounded ends, sterilized, 25/bag [2]	19290/1105

Semen transfer adapter for syringe, length: 13 cm, 10/bag [3]	17229/0020
---	------------

Hygienic sheaths

Hygienic sheaths are used during AI and ET to keep the instruments clean while they pass the vagina until they reach the cervix.

Hygienic sheaths for artificial insemination, length: 46 cm, 80/box [1]	17028/0100
---	------------

Hygienic sheaths for embryo transfer, length: 53 cm, 80/box [2]	19271/0080
---	------------

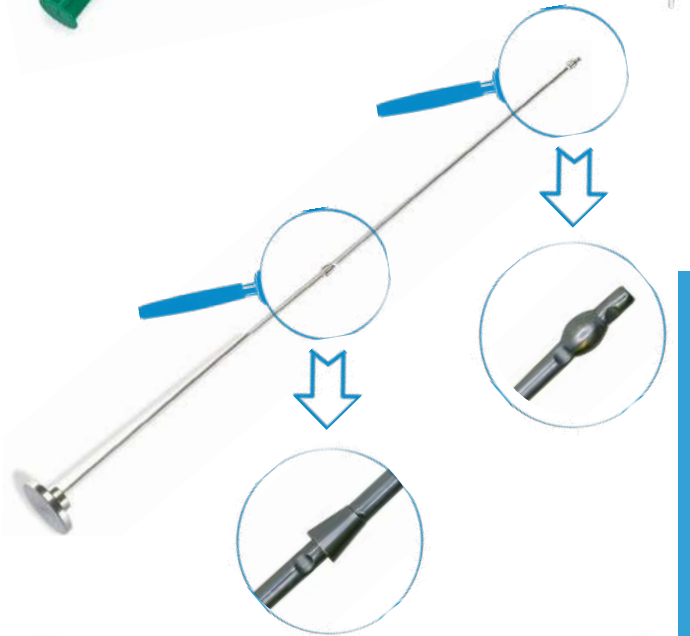

1



2

MiniThaw thawing unit

- Variable temperature setting (ambient to +50°C)
- Digital display of current temperature
- Straw lift has three compartments and allows thawing of up to 10 straws at a time (0.5 ml or 0.25 ml)
- Connects to on-board 12-24 V socket and to mains 110-230 V socket via USB-C cable or adapter
- Robust and easy to handle

MiniThaw with USB-C cable [1] 17048/0001

Accessories

USB car adapter to connect to on-board 12-24 V socket 17048/0420

USB mains converter to connect to mains 110-230 V socket 17048/0430

Base for MiniThaw, metal [2] 17048/0005

Digital timer, magnetic, battery included [3] 17048/0006



MiniCutter

- Precise cutting of 0.25 and 0.5 ml straws
- Facilitates straight cut at exactly the right length, which helps to avoid semen loss
- Ergonomic shape
- Easy to keep clean

MiniCutter for straws 17062/0010



Insemination gloves

Recyclable polyethylene gloves that are both flexible and strong, giving you excellent feel combined with good protection. The reduced diameter of the glove will help to keep it on your arm without compromising its robustness.

Insemination gloves, 5 finger, shoulder length

sensitive, green, 100/box [1] 17080/0015

super-sensitive, transparent, 100/box 17080/0050

super-sensitive, transparent, single packed, sterilized, 50/box 17080/0052

green, single packed, sterilized, 50/bag [2] 17080/0250



Uterus culture swab

Introduction pipette with pre-perforated cap for sampling without risk of contamination. Predetermined breaking point of the sample-protecting sheath. Includes two closing caps for transport of the swab to the lab. Swab may be inserted directly into AMIES transport medium to avoid dehydration of the sample.

Uterus culture swab , individually packed, sterilized, 10/bag	
with AMIES transport medium	17214/2951
without transport medium	17214/2950



Cytology brush

For picking up cells of the uterus of mares to perform cytology smears for immediate evaluation.

Cytology brush , individually packed, sterilized, 10/bag, with transport box for slides	17214/2960
--	------------



Colostrum refractometer

Determines the amount of immunoglobulin in the mare colostrum to ensure sufficient supply for the newborn foal. Colostrum of good quality should be frozen for emergency use. Only one drop of colostrum is required for testing. No batteries, no consumables, easy handling.

Colostrum refractometer	24400/0150
--------------------------------	------------



Specula and forceps

Disposable speculum , made of cardboard with reflecting aluminum coating, smooth front edge for gentle introduction, inner diameter: 3 cm, length: 43 cm, sterilized, 100/box [1]	17210/0000
--	------------

Polansky speculum , stainless steel [2]	17210/4200
--	------------

Götze Cervical forceps , stainless steel, 54 cm	
with mounted lamp [3]	17212/0055
without lamp	17212/0054

Biopsy forceps , shaft: 60 cm, 4 x 28 mm jaw, stainless steel [4]	17214/5066
--	------------

Accessories

Metal case , with lid and handles for sterilization and transport of speculum and cervical forceps, 560 x 230 x 120 mm (W x H x D) [5]	17215/0149
---	------------

LED-light , battery operated (up to 250 h), with clip for fixing, length: 96 mm [6]	17210/0010
--	------------



8 EMBRYO TRANSFER AND OPU



Embryo flushing catheters for mares

All sizes allow high-flow of flushing media in combination with high-flow Y-junction. The balloon (100 ml), when inflated, facilitates tight closure of the cervix.

Product features

- Single packed, sterilized
- Length: approx. 90 cm
- Foley end, large front ports
- CH 28: closed end, CH 32 and CH 36: open end
- Made of silicone, sterilizable

Embryo flushing catheter

CH 28	19009/0028
CH 32	19009/0032
CH 36	19009/0036

Flushing catheter extension, high flow, length: 60 cm, spike port 19009/0041

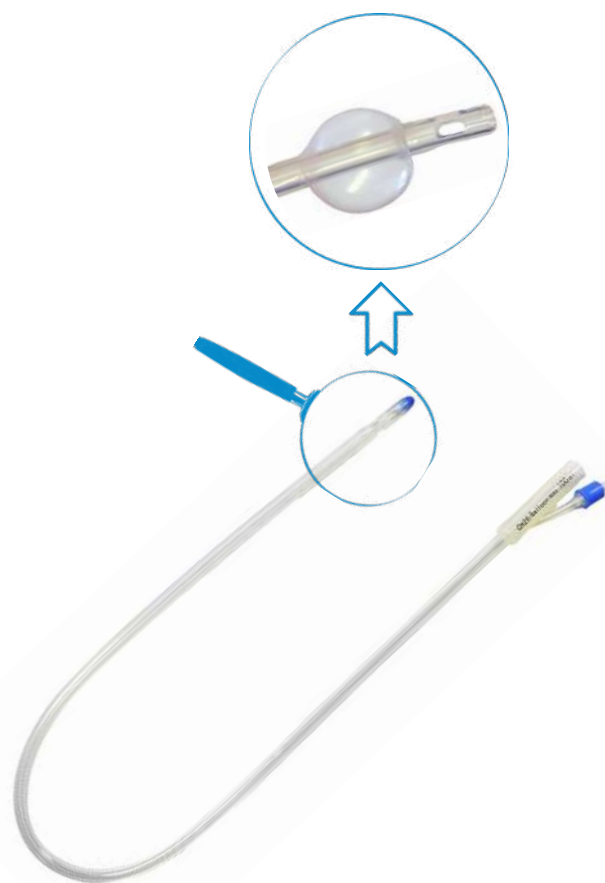

EASY AND SAFE TO USE

All-in-one dual-purpose filters and search dishes that require no attention during flushing procedure. Embryos are recovered directly from the filter dish.

Filters for embryo collection

Product features

- Secure fixation of the lid during collection and easy to open after collection (no screw cap)
- Integrated search dish engraved with a grid makes it easy to search and find embryos (ideal mesh size for all embryo sizes)
- Also suitable for filtering oocytes after OPU
- Filter mesh cannot dry out as it remains in contact with fluid
- Excess fluid is controlled and removed through outlet tubing with attached thumb clamp (entry hole is big enough to ensure the necessary flow speed of the flushing medium)
- Connection to all types of Y-tubing is possible
- Sterilized and absolutely tight

EmSafe

Product features

- Maintains a constant 60 ml of flushing fluid in the dish
- Air vent in the lid and air outlet are provided with a filter which is holding embryos securely in the system

EmSafe filter

19010/6000

Miniflush®

Product features

- Vertical recovery system with large filter surface area
- Maintains a constant 20 ml volume during the entire flushing procedure
- Due to its shallow design, search dish is perfectly suited for use with all microscopes

Miniflush® filter

19222/2000

Flushing tubing

Disposable Y-junction tubing with clamps, to be used in combination with any catheter. Tubing made of very smooth, flexible material. End for filter connection requires no extra adapter. Sterilized, 1/bag.

Y-junction tubing, large lumen, spike port

19982/0202



EquiFlush

Ready-to-use medium for equine embryo recovery. Complete formulation containing buffers, BSA or PVA and antibiotics.

- Available in plastic bottles and infusion bags
- Bottles with tab on the bottom to hang them up and rubber stopper for easy connection of the Y-tubing
- Infusion bags with 3-way port configuration and sealed ports for hygienic fluid removal
- Graduation in steps of 100 ml simplifies dosage and allows monitoring the volume during flushing



Recovery medium

EquiFlush	
with BSA and antibiotics, 1 l, bag	19982/6201
with BSA and antibiotics, 2 l, bag	19982/6202
with BSA and antibiotics, 1 l, bottle	19982/6205
with PVA and antibiotics, 1 l, bag	19982/6211
with PVA and antibiotics, 2 l, bag	19982/6212
with PVA and antibiotics, 1 l, bottle	19982/6213

EquiHold

Ready-to-use holding medium for equine embryos. Contains buffers, glucose, pyruvate, BSA, amino acids, growth factors and antibiotics. Applicable for:

- Holding embryos at ambient conditions
- Transporting embryos
- Washing and rinsing embryos
- Loading embryos for transfer to recipient animal



Holding medium

EquiHold, 3 x 5 ml	19982/6250
--------------------	------------

Equine VIT-Kit

Vitrification kit for direct transfer vitrification of equine embryos. The kit contains everything needed for the vitrification of 3 embryos:

- Equilibration medium (3 x VS1, 3 x VS2, 3 x VS3)
- 3 x diluent
- 1 x syringe 1 ml for loading straws
- 1 x pipette tip (straw adapter)
- 4 x 5-well culture dish
- 10 x 0.25 ml sterilized straws for vitrification
- 10 x 0.5 ml sterilized straws for transfer
- 3 x ID rod
- 1 x aluminum cane
- 3 x goblet 10 mm



Equine VIT-Kit	19982/6251
----------------	------------

Stereo-zoom microscope

Product features

- Mirror with LED illumination for improved visualization of zona pellucida
- Total magnification from 10x to 70x
- 2 eyepieces 10x
- 110 V/60 Hz or 230 V/50 Hz

Stereo-zoom microscope

binocular	12014/0000
trinocular	12014/1000



Wide range of microscopes and accessories available!

Temperature control

Heated stage, placed on top of the light base of a stereo microscope, 180 x 180 x 10 mm, requires a control unit [1]

Control unit HTi 50, for heated stage, adjustable temperature, digital display [2]

Laboratory heating plate, heated area: 470 x 260 mm, preset temperature (+37°C), integrated control unit and external power supply [3]

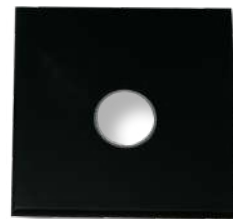

1



2



3

Embryo handling

5-well dish with lid, sterilized, rounded well edges, MEA tested, 4/package [1]

Steripette, 60 mm, individually packed, sterilized, for use with 1 ml insulin syringe, 50/package [2]

Disposable syringe, 1 ml, Luer mount, sterilized, all plastic, non-spermicidal, 100/package

Micropipettor, easy and precise pipetting by handling wheel, for all sizes of capillary tubes up to 1 ml

Model A 19022/0000

Model B 19022/0002

Hard glass capillary, 250/package

20 µl 19022/0020

50 µl 19022/0050

Petri dish

diameter 35 mm 19020/0035

diameter 94 mm 19020/0094

diameter 145 mm 19020/0145

with grid, diameter 65 mm [3] 19020/2065



1



2

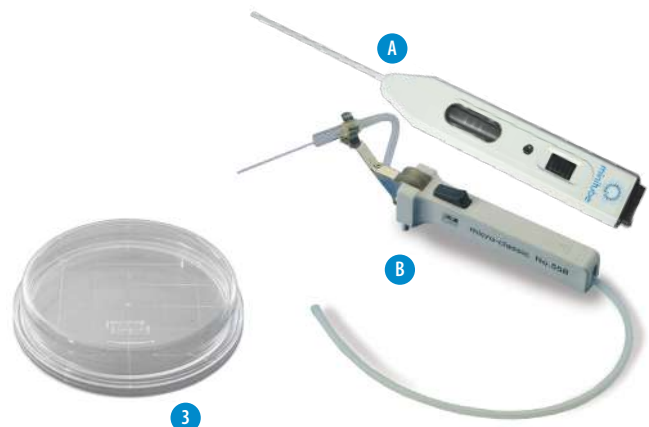

3

Embryo transfer with 0.5 ml straws

Equine ET sheath, individually packaged, sterilized, 10/package front end opening [1]	19290/1050
side openings [2]	19290/1060
Stiff stylet, with white thumb rest	19290/1049
Flexible stylet, length: 65 cm	17209/1065
Finger support and ring, used with equine ET sheath and AI stylet [3]	19290/1048
Equine ET pipette, metal tip with side opening, flexible, disposable, sterilized, 1/package [4]	19290/1065
Stiff stylet, with white thumb rest	19290/1049
Flexible stylet, length: 65 cm	17209/1065
ET cannula, used with 0.5 ml straws, 1 side outlet, length: 55 cm, screw-off tip, stainless steel [5]	19290/0000

Option A:
19290/1050 or 19290/1060
+
19290/1049 or 17209/1065
+
19290/1048

Option B:
19290/1065
+
19290/1049 or 17209/1065

Option C:
19290/0000

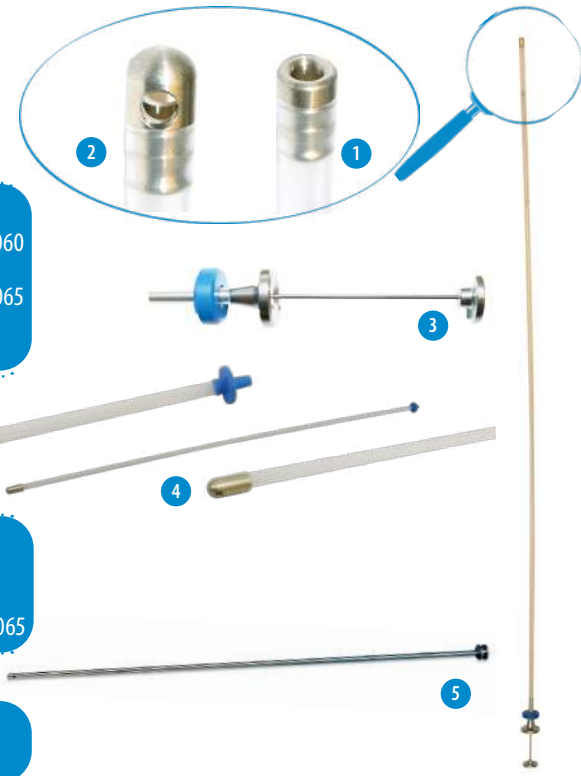

Embryo transfer with 0.25 ml straws

Deep intrauterine AI/ET set, introduction stylet, flexible AI/ET stylet, finger support, two fixation rings, for embryo deposition deep inside the uterine horn using 0.25 ml straws and DIUI sheaths	17015/0100
DIUI sheath for 0.25 ml straw	
10/bag	17015/0650
1/bag, sterilized	17015/0660



Embryo transfer > day 8

Large diameter pipette for equine AI and ET > day 8, rounded ends, fits Luer syringe, length: 65 cm, sterilized	
1/bag	19290/1101
25/bag	19290/1105



Straws

0.25 ml straw, 133 mm, sterilized, transparent, 10/package	
without seal	19042/0010
with glass sealing ball	19041/0010
with white ID rod seal (other colors available) [1]	19040/0010

0.5 ml straw, sterilized, transparent	
133 mm, with sealing ball, 1/package [2]	19043/0001
133 mm, with sealing ball, 10/package	19043/0010
133 mm, without sealing ball, 1/package	19043/1011
133 mm, without sealing ball, 10/package	19043/1010
90 mm, without wick, 10/package	19044/9110

ET identification rod, for sealing of 0.25 ml straws, 100/package, white (other colors available) [3]	19046/0010
---	------------

Pen for marking, very fine, alcohol permanent, black	19045/0100
--	------------



CryoSealer

Manual sealer using ultrasound technology. Can be used for 0.25 and 0.5 ml straws. Ultrasound welding facilitates a perfect and uniform seal of each straw. Power supply: 100-240 V AC/50-60 Hz.

CryoSealer	13135/0000
------------	------------



Manual sealer

Manual sealer for straws, securely seals all kinds of straws by applying heat at the end of the straws (also in liquid nitrogen vapor). Consists of a plier welding head adapted for straws and a control unit for varying heat level.

Manual sealer	13135/2500
---------------	------------



Manual ball sealer

0.5 ml straws are individually sealed with the balls.

Manual ball sealer	13136/0100
--------------------	------------



EquiPlus OPU recovery medium

Complete solution, ready-to-use, containing BSA and Heparin to avoid blood coagulation during the OPU procedure.

EquiPlus OPU recovery medium, 500 ml	
with PVA	19982/2283
with BSA	19982/2281



Ultrasound device GE Versana Active

Product features

- Portable, easy-to-use ultrasound system for linear and convex sector probes
- High quality documentation and data transfer system
- Display modes: B-Mode, M-Mode
- PW Color Doppler with automatic calculation
- Realtime Triplex-Mode
- Coded Harmonic Imaging, CrossXBeam, Speckle Reduction Imaging (SRI-HD) for exceptional image quality
- Connectivity: USB, HDMI, Ethernet
- Monitor: 15.6" high-resolution LCD
- Dimensions: 39 x 5.8 x 36.2 cm (W x H x D)
- Weight: 5 kg with battery
- Electrical connection: 100-240 VAC/50-60 Hz



Ultrasound device GE Versana Active	23360/0000
-------------------------------------	------------

Accessories

Convex sector probe, 6.0 - 10.0 MHz	23360/0002
Endorectal linear probe, 3.5 - 10.0 MHz	23360/0003

Ultrasound probe holder

Product features

- Has a needle guide included and is used with the double lumen needle: the two spaces allow simultaneous or alternating aspiration and injection of fluids into and from the follicles
- OPU needle is connected to the aspiration and flushing pump for equine OPU, Ref. 23362/0002 (230 V) or 23362/0003 (115 V)
- The needle has an echogenically marked tip, which improves tip visibility during ultrasound exams

Ultrasound probe holder [1]

for GE probe	19009/3100
for Esaote probe	19009/3101
for Sonosite probe	19009/3102
for BCF/Mindray probe	19009/3103

Accessories

Double lumen needle, 12 G, 25", consists of outer needle and inner cannula [2]

Replacement needle, 12 G, 25" 19009/3106

Cover for probe holder, 144/package 23360/1260

Aspiration and flushing pump for OPU

OPU pump for follicle aspiration and flushing, oocyte collection in mares with durable casing.

Product features

- Two pumps and a warming block are combined into one unit for convenient oocyte aspiration
- Pressure levels and hysteresis are programmable by the user
- The pump is operated by foot switches

Aspiration and flushing pump for OPU [1]

220-240 V/50-60 Hz	23362/0002
110-115 V/50-60 Hz	23362/0003

Accessories

Stopper assembly, snugly connects to 50 ml tubes, 1/package [2]

Disposable tubing, for transvaginal oocyte aspiration in mares [3]

Upon request we offer the device also adapted to other probes.



Embryo transfer and OPU/IVP



more information

9 TRAINING AND SERVICE



Training and education

Minitube offers specialized product training and educational seminars in assisted reproduction technologies worldwide. Individual and open seminars providing instructions in artificial insemination, embryo transfer, semen analysis, semen processing and more are offered according to demand.

All training courses blend theoretical knowledge and practical experience. Our instructors are well-respected experts in assisted animal reproduction. Minitube cooperates closely with leading studs, universities, and research centers. The collective experience and knowledge are incorporated into our seminars where the latest technologies and practices are demonstrated and trained with the participants.

The courses are interactive workshops where presentations, discussions, demonstrations, and practical exercise go hand in hand. Minitube training sessions offer useful troubleshooting tips, and the trainees benefit from the “learning by doing” approach. Participants receive valuable documentation and a certificate of participation. Minitube trainings are very flexible and available at Minitube premises, at partner facilities, at the customer site and virtually.

We are happy to find the best training option for you.
Please contact us: seminar@minitube.de

Mobile lab service

Minitube Middle East offers unique professional lab service to customers particularly in remote areas. The Mobile Lab is a van equipped with high-quality Minitube equipment to analyze and preserve/freeze animal semen or embryos.

Minitube Middle East offers the service to customers in the United Arab Emirates, Saudi Arabia, and Oman, in regions which otherwise have no access to a professional laboratory for semen and embryo preservation.

Please contact us for further information about the service and if you would like to discuss how to construct your own mobile laboratory: minitube@minitube.de







MINITUBE INTERNATIONAL

Servicing reproduction technologies worldwide

Minitube USA

800.646.4882
info@minitube.com

Minitub do Brasil

+55 51 3222 7876
minitub@minitube.com.br

Minitube India

+91 11 4309 0668
info@minitube-india.com

Minitube China

+86 185 1545 5770
info@minitube.cn

Minitub Ibérica

+34 977 845 397
info@minitub-iberica.com

Minitube Australia

+61 3 5342 8688
info@minitube.com.au

Minitube Central Europe

+421 377 877 915
mtce@minitube.sk

Minitube Canada

800.500.7978
info.canada@minitube.com

Mexitube Alemania

+52 442 246 73 46/47
info@mexitube.mx

Minitube Middle East

+971 426 68871
info.middle.east@minitube.com

Minitube Indonesia

+62 21 7591 75-96/94
info@minitube.co.id

Minitube International AG, Germany

+49 8709 9229 0
minitube@minitube.de

Follow us



www.minitube.com

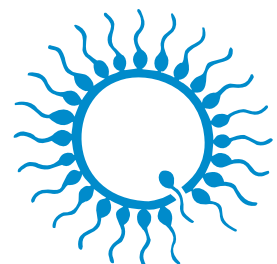

minitube
our knowledge, your success